

PLUMBING SHEET NOTES	
1	ROUTE DOMESTIC HW/CW PIPING UNDER FLOOR.
2	DOMESTIC HW PIPING FROM FLOOR ABOVE.

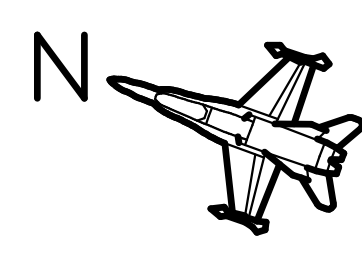

DOMESTIC PIPING NEW WORK ENLARGED PLAN - WEST

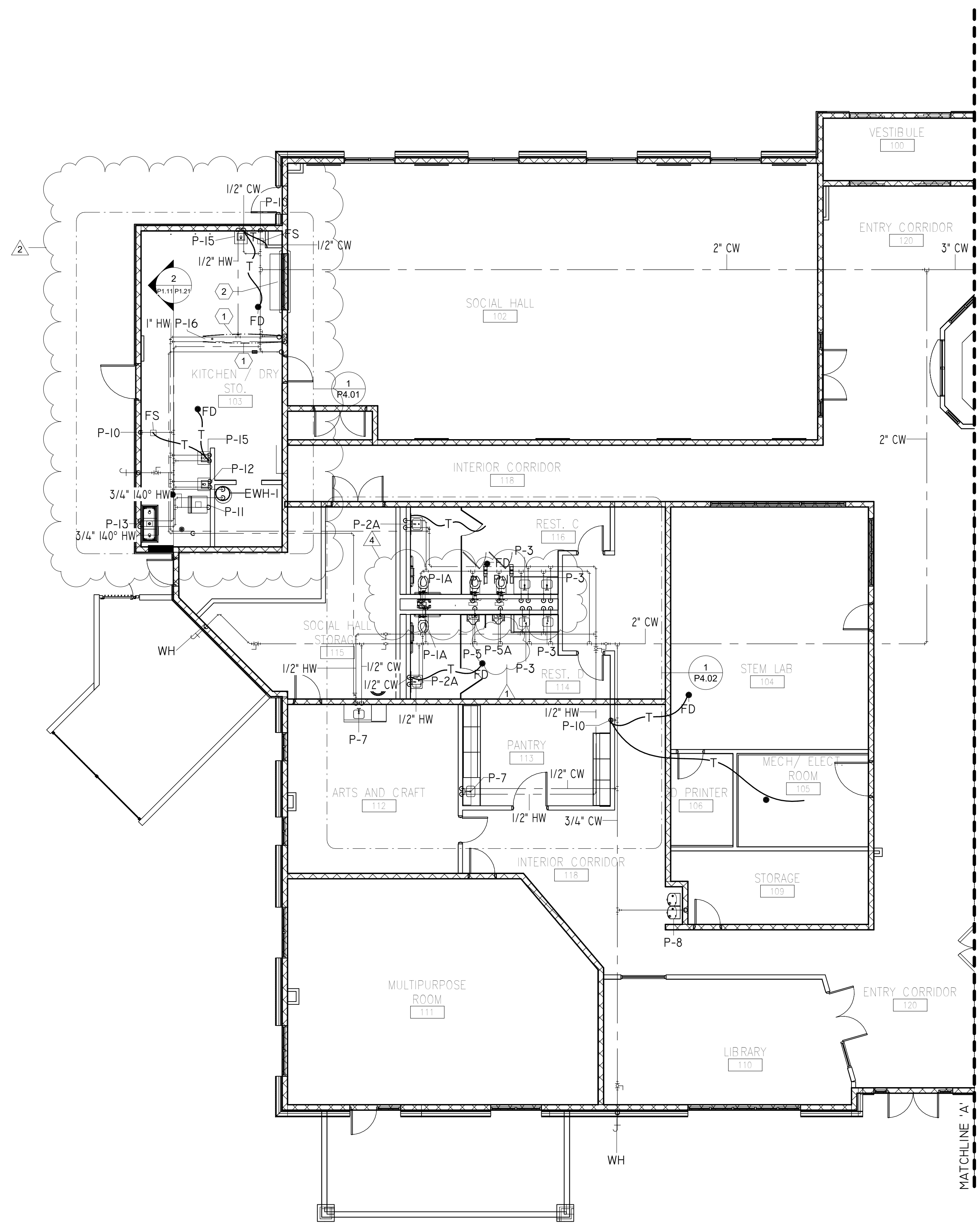
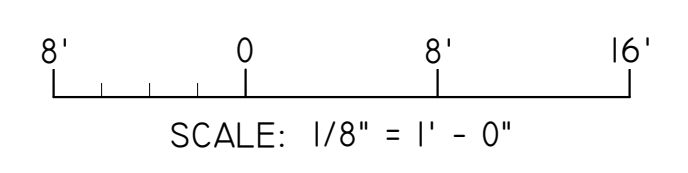

G OODWYN MILLS CAWOOD, LLC.
 720 Bayfront Parkway, Suite 200
 Pensacola, FL 32502
 T 850.432.0706
GMCNETWORK.COM
 Gerald Steven Jamigan -
 Qualifying Agent
 FL Architect AR 0008953

ISSUE	DATE
PERMIT SET	12/06/2025
1	05/07/2026
2	REV. 02
4	REV. 04
	6-9-26

DRAWN BY: CNA
 CHECKED BY: JEW3

**FRICKER RESOURCE CENTER
 RENOVATION PROJECT**

900 N F St, Pensacola, FL 32501-2887

GMC # APEN250016

**DOMESTIC PIPING NEW
 WORK ENLARGED PLAN
 (WEST)**

P1.11



W3 Engineering Inc.
 110 E. WRIGHT ST.
 PENSACOLA, FL 32502
 T: (850) 629-8270
 F: (888) 478-4898
 FL P.E. # 70595
 FL AUTHORIZATION #: 31078

6/14/2026 11:42:10 AM
 TEMPLATE VERSION:
 20201

PLUMBING SHEET NOTES
 1 PROVIDE SOLIDS INTERCEPTOR. BASIS OF DESIGN: STRIEM AA-2.

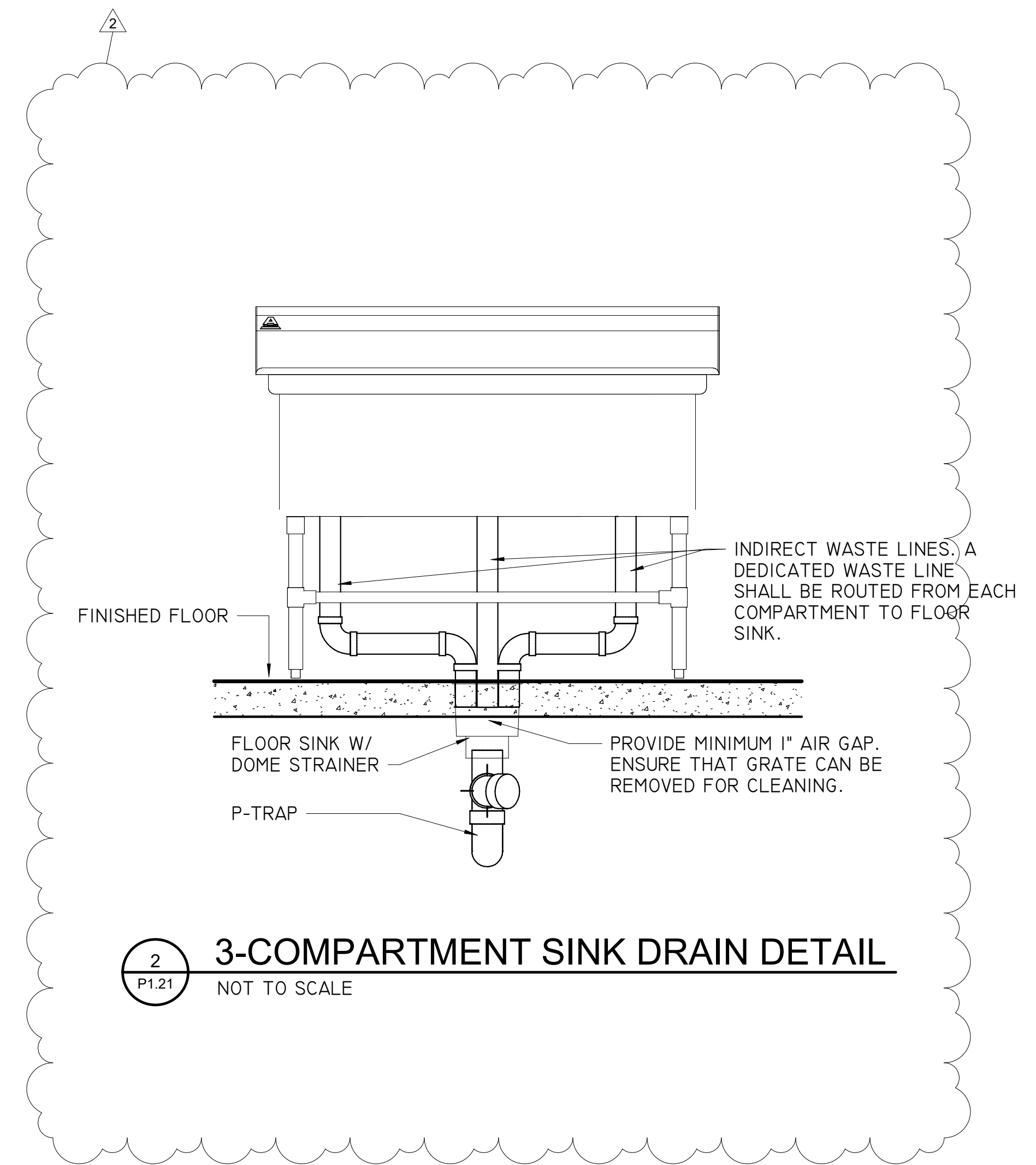
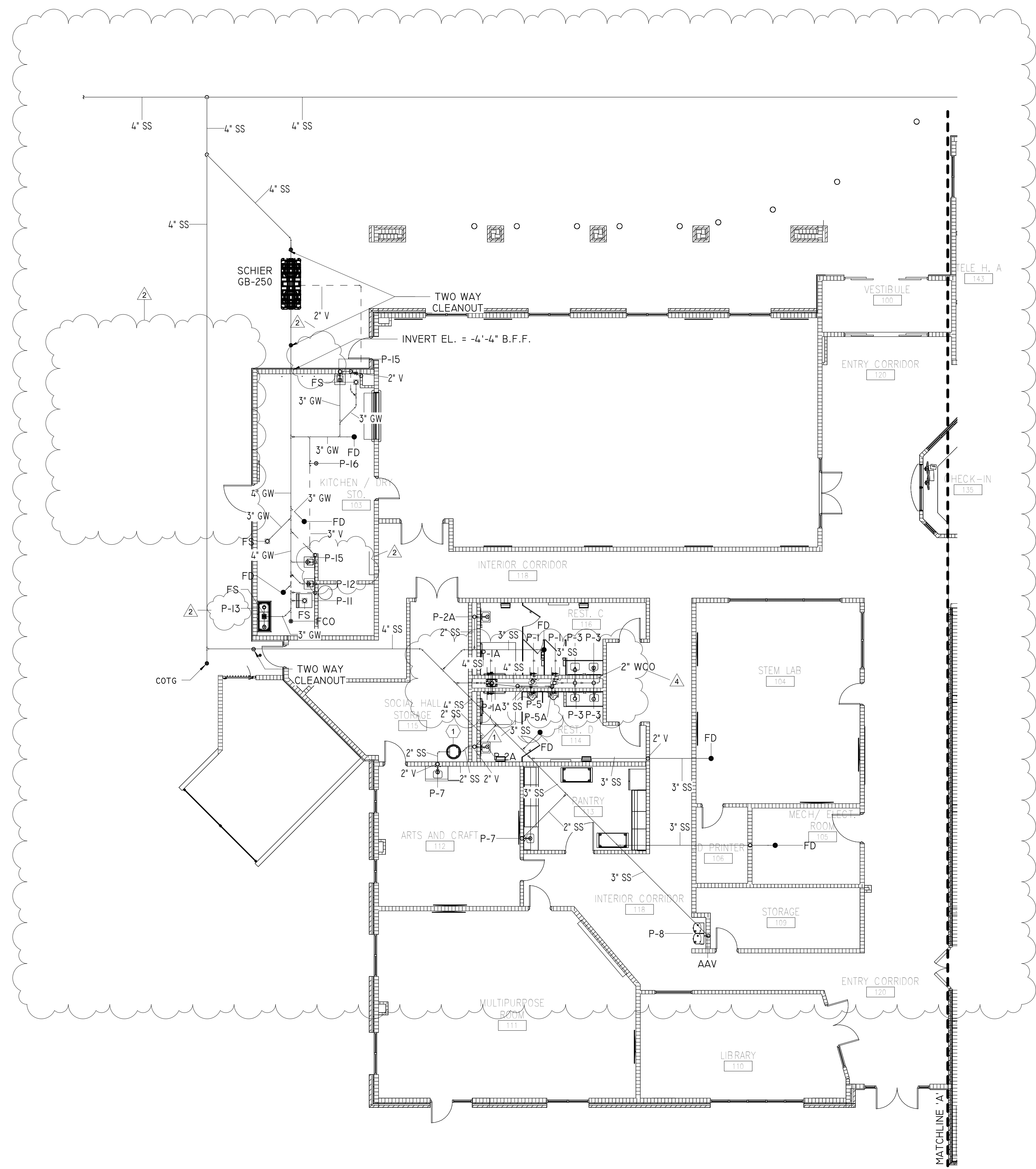

SANITARY PIPING NEW WORK PLAN - WEST
 SCALE: 1/8" = 1' - 0"

FRICKER RESOURCE CENTER RENOVATION PROJECT

GMC
 G GOODWIN MILLS CAWOOD, LLC.
 720 Bayfront Parkway, Suite 200
 Pensacola, FL 32502
 T 850.432.0706
GMCNETWORK.COM
 Gerald Steven Jamigan -
 Qualifying Agent
 FL Architect AR 0008953

ISSUE	DATE
1 PERMIT SET	12/06/2025
2 REV. 02	05/07/2026
4 REV. 04	6-9-26

900 N F St, Pensacola, FL 32501-2887
 DRAWN BY: CNA
 CHECKED BY: JEW3
 GMC # APEN250016

W3 Engineering Inc.
 110 E. WRIGHT ST.
 PENSACOLA, FL 32502
 T: (850) 629-8270
 F: (888) 478-4898
 FL P.E. #: 70595
 FL AUTHORIZATION #: 31078

P1.21

6/14/2026 11:42:23 AM
 TEMPLATE VERSION
 2020.1

PLUMBING SHEET NOTES
 I PROVIDE SOLIDS INTERCEPTOR. BASIS OF DESIGN: STRIEM AA-2.

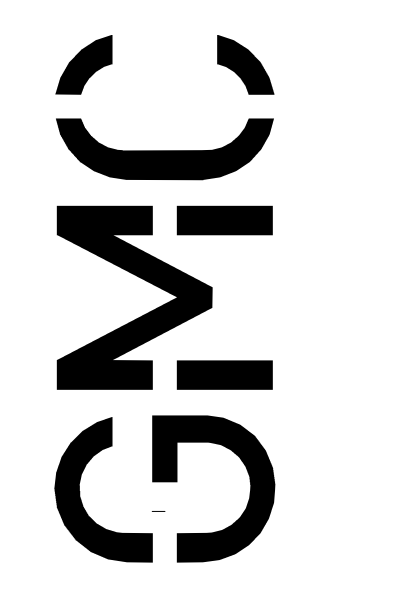

G OODWYN MILLS CAWOOD, LLC.
 720 Bayfront Parkway, Suite 200
 Pensacola, FL 32502
 T: 850.432.0706
GMCNETWORK.COM
 Gerald Steven Jamigan -
 Qualifying Agent
 FL Architect AR 0009953

ISSUE	DATE
PERMIT SET	12/06/2025
2 REV. 02	05/07/2026
4 REV. 04	6-9-26

**FRICKER RESOURCE CENTER
 RENOVATION PROJECT**

900 N St, Pensacola, FL 32501-2887

GMC # APEN250016
 DRAWN BY: CNA
 CHECKED BY: JEW3

**PLUMBING NEW WORK
 ENLARGED PLAN -
 RESTROOM C/D**

P4.02

W3 Engineering Inc.
 110 E. WRIGHT ST.
 PENSACOLA, FL 32502
 T: (850)629-8270
 F: (850)478-4898
 FL P.E. #: 70595
 FL AUTHORIZATION #: 31078

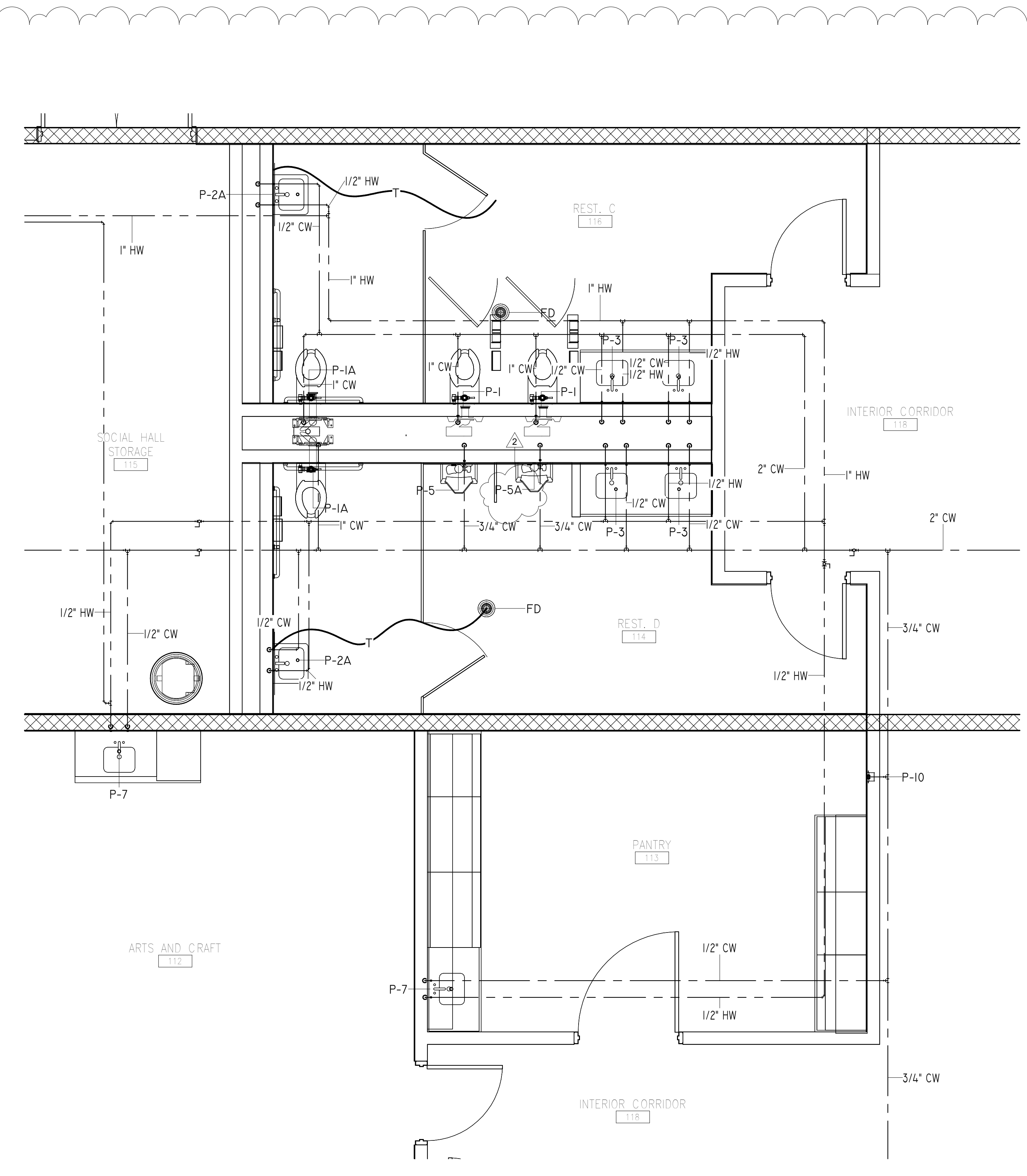

DOMESTIC PIPING NEW WORK ENLARGED PLAN - RESTROOM C/D
 SCALE: 3/8" = 1' - 0"

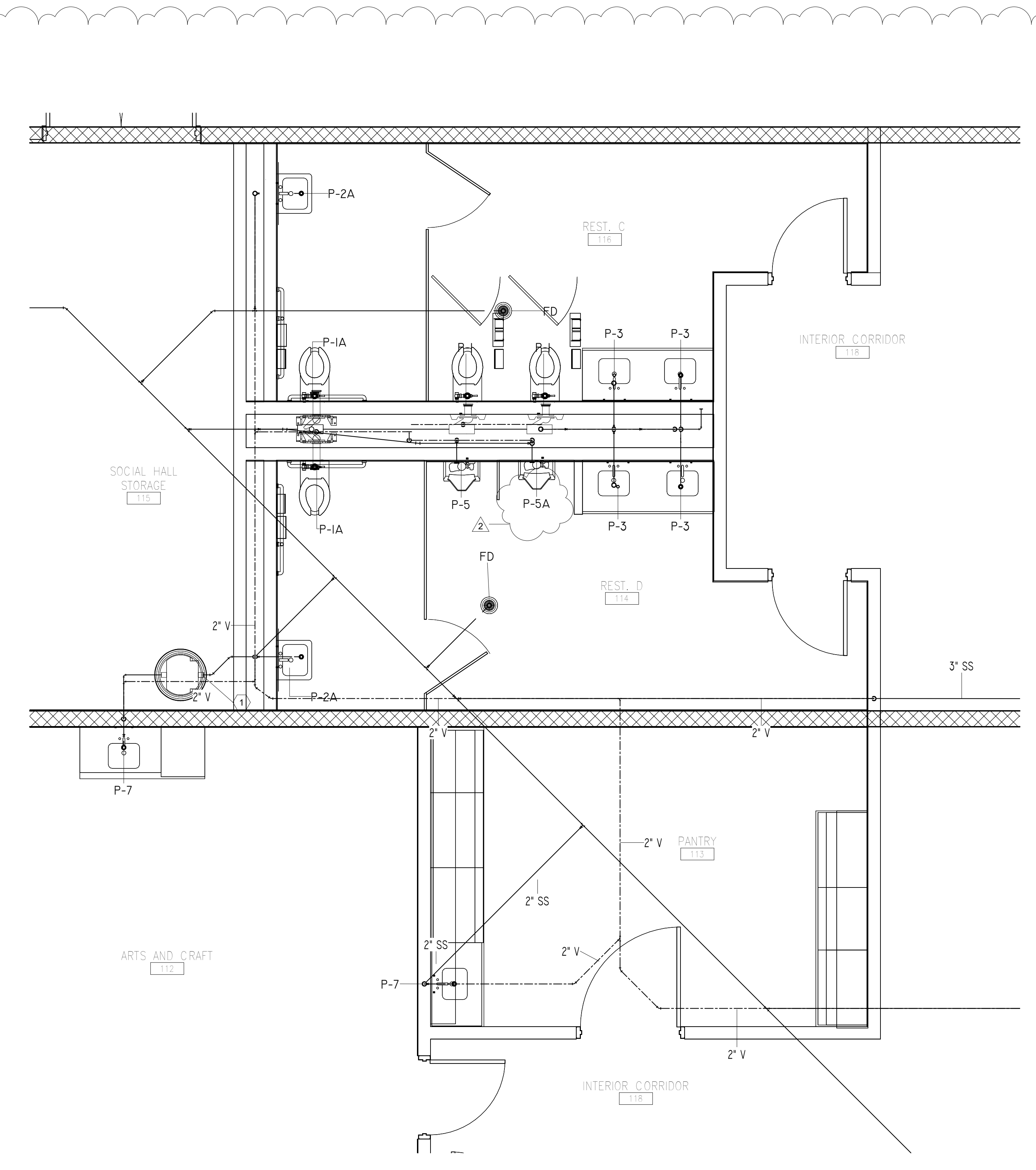

SANITARY PIPING NEW WORK ENLARGED PLAN - RESTROOM C/D
 SCALE: 3/8" = 1' - 0"

6/14/2026 11:42:32 AM
 TEMPLATE VERSION
 20201

6/14/2026 11:42:37 AM
TEMPLATE VERSION
20201

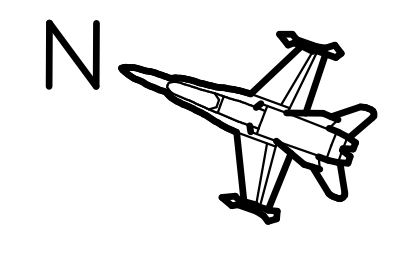
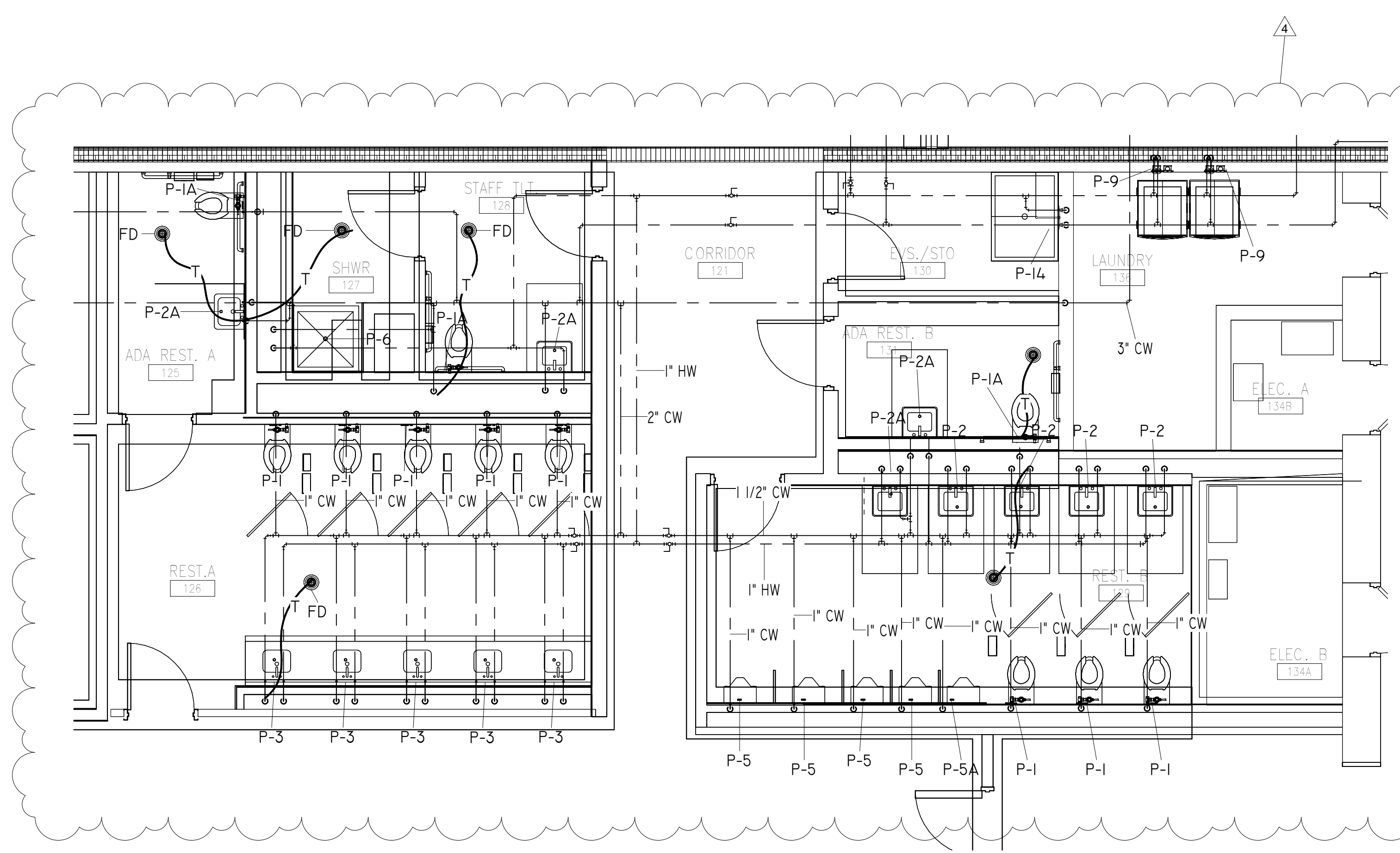

DOMESTIC PIPING NEW WORK ENLARGED PLAN - RESTROOM A/B

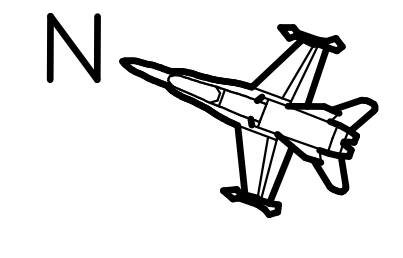
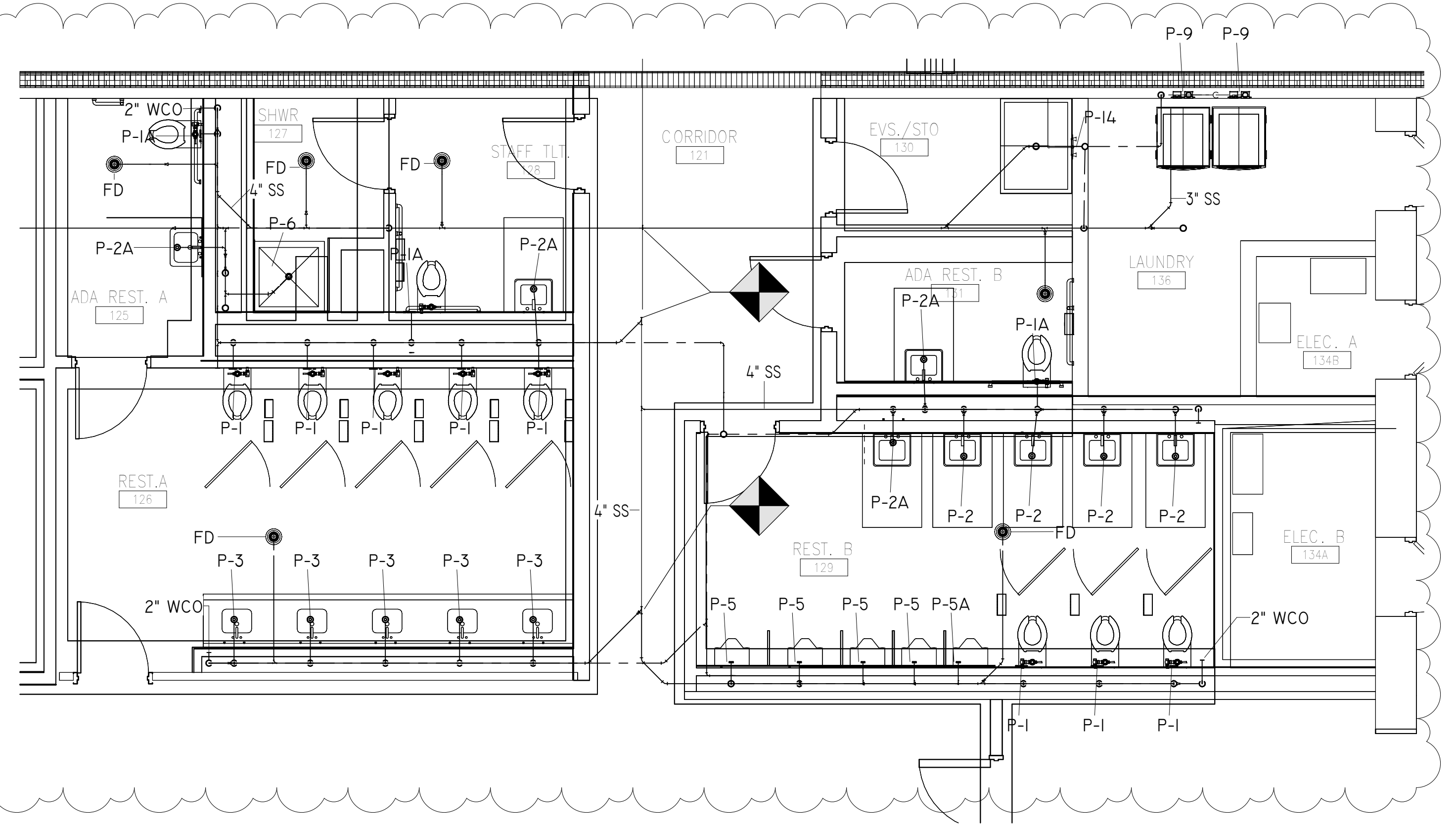
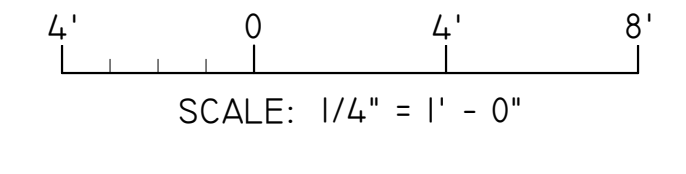

SANITARY PIPING NEW WORK ENLARGED PLAN - RESTROOM A/B

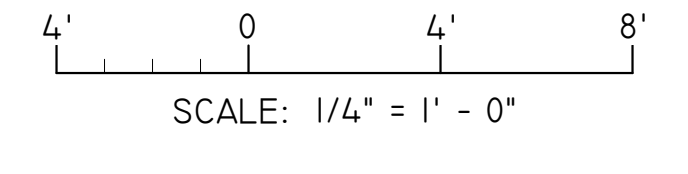

W3 Engineering Inc.
110 E. WRIGHT ST.
PENSACOLA, FL 32502
T: (850) 629-8270
F: (888) 478-4898
FL P.E. #: 70595
FL AUTHORIZATION #: 31078

**PLUMBING NEW WORK
ENLARGED PLAN - EAST
RESTROOM**

P4.03

**FRICKER RESOURCE CENTER
RENOVATION PROJECT**

900 N ST, Pensacola, FL 32501-2887

GMC # APEN250016

ISSUE	DATE
PERMIT SET	12/06/2025
4 REV. 04	6-9-26

DRAWN BY: CNA
CHECKED BY: JEW3

G GOODWYN MILLS CAWOOD, LLC.
720 Bayfront Parkway, Suite 200
Pensacola, FL 32502
T: 850.432.0706
GMCNETWORK.COM
Cecilia Steves Jemigan -
Qualifying Agent
FL Architect AR 0009953

